

**Wireless Battery Uplighter  
FOS Luminus PRO  
RGBWA+UV  
USER'S MANUAL**



---

Before you operate this fixture read the manual carefully. Always make sure to include the manual if you pass/rent/sell the fixture to another user.

# TABLE OF CONTENT

- 1. Warning .....2**
  - 1.1 Safety Instructions .....2
  - 1.2 Rigging .....3
- 2. Product Introduction .....3**
  - 2.1 Items in the Package .....3
  - 2.2 Product Overview.....3
  - 2.3 Fixture Temperature .....6
  - 2.4 Storing the Fixture .....6
  - 2.5 Mounting .....6
  - 2.6 Specifications..... 7
- 3. Battery Charge .....8**
  - 3.1 Battery Charge .....8
  - 3.2 Battery Life Indicator.....8
- 4. Product Setup .....9**
  - 4.1 OLED Display Back Ligh.....9
  - 4.2 ECO Mod.....9
  - 4.3 Menu Map .....9
  - 4.4 DMX Addressing .....10
  - 4.5 Wireless DMX Setup .....11
  - 4.6 DMX Signal Fail .....12
- 5. Operation .....13**
  - 5.1 DMX Control Mode.....13
  - 5.2 Master/Slave Mode .....14
  - 5.3 Auto Run Mode .....14
  - 5.4 Sound Mode .....15
  - 5.5 Manual Color.....15
  - 5.6 IR Remote Control .....15
- 6. Maintenance.....16**
  - 6.1 General Maintenance .....16
  - 6.2 Fuse Replacement .....17

# 1. WARNING

## 1.1 Safety Instructions

This product guide contains important information about the safe installation and use of this product. Please read and follow these instructions carefully and keep this manual in a safe place for future reference.

When unpacking and before disposing of the carton, check there is no transportation damage before using the product. Should there be any damage caused by transportation, consult your dealer and do not use the products.

The product is for indoor use only. Use only in dry locations. Keep this device away from rain and moisture, excessive heat, humidity and dust. Do not allow contact with water or any other liquids. The product is not designed or intended to be mounted directly on to inflammable surfaces. 

The product is only intended for installation, operation and maintenance by qualified personnel.

The product must be installed in a location with adequate ventilation, at least 50cm from adjacent wall surfaces. Be sure that no ventilation slots are blocked.

Do not directly look into the led. It can cause harm to your eyes.

Do not attempt to dismantle and/or modify the product in any way.

Electrical connection must only be carried out by qualified personnel.

Before charging the fixture, ensure that the voltage and frequency of power supply match the power requirements of the product.

A rechargeable lithium ion battery is built inside this fixture. Please avoid bumping or plunging, it may cause fire or explosion. Never store the battery when fully drained. Always recharge immediately when empty. Make sure to fully charge all fixtures before storing them. Partially charged batteries will lose capacity. Fully recharge every 6 months if not used.

When charging fixtures in flight case, always charge with the case open. It is recommended to charge at a temperature between 0°C and 35°C.

Please make sure the battery will be disposed of properly according to your local law when it runs out of its life, so that to protect the environment.

This product is not designed for permanent operation. Consistent operation breaks will ensure that the device will serve you for a long time without defects.

If this fixture is operated in any other way other than the one said in this manual, this device may suffer damages and thus the warranty becomes void.

**Always switch off the fixture when it is not in use or before cleaning it or before attempting any maintenance work.**

**IMPORTANT:**

**The manufacturer will not accept liability for any resulting damages caused by the non-observance of this manual or any unauthorized modification to the fixture.**

## **1.2 Rigging**

Concerning rigging, trussing for this fixture, please follow the European and national guidelines.

Only the qualified technicians are allowed for the device installation,

The fixture must never be mounted for a possible swinging position, and a safety cord attached must always be used.

## **2. PRODUCT INTRODUCTION**

### **2.1 Items in the Package**

After receiving the fixture, please carefully unpack the product and make sure the following parts are all included inside the package and are all in good condition.

- 1 x H6 fixture
- 1 x Power cable 1.5m
- 1 x IR controller
- 1 x fuse
- 1 x manual

In case the package is damaged from shipping, inform the carrier right away while keeping the damaged box or flight case for inspection. Failure to report damage to the carrier immediately may cause invalidity to your claim. The dealer or manufacture will not take any responsibilities for the damage.

In case there are parts missing from the box with a good condition, please contact your dealer or the manufacturer immediately by email or in other written form.

### **2.2 Product Overview**

H6 is a battery powered led luminaire with wireless DMX transceiver. This luminaire features 6 pieces of super bright RGBWA+UV hex color led, and can create more vivid color changing effects besides RGBWA color mixing, and wide range of color temperatures.

H6 has a built-in rechargeable lithium-ion battery fully protected against overcharging to maximize battery life span.

H6 uses a very stable wireless DMX transceiver (W-DMX Sweden compatible). The fixture can also be controlled with infrared remote controller. The IR controller can help users to achieve all working functions.

This highly compact luminaire has very small dimensions that can be used not only as an uplighter but also as truss warmer. Its tilt can manually move 25 degrees when needed. It is absolutely an ideal tool for mobile DJ/Bands, wedding, exhibitions, ball room and hotel banquet halls etc.

**2.2.1 Fixture Elements and Connectors**

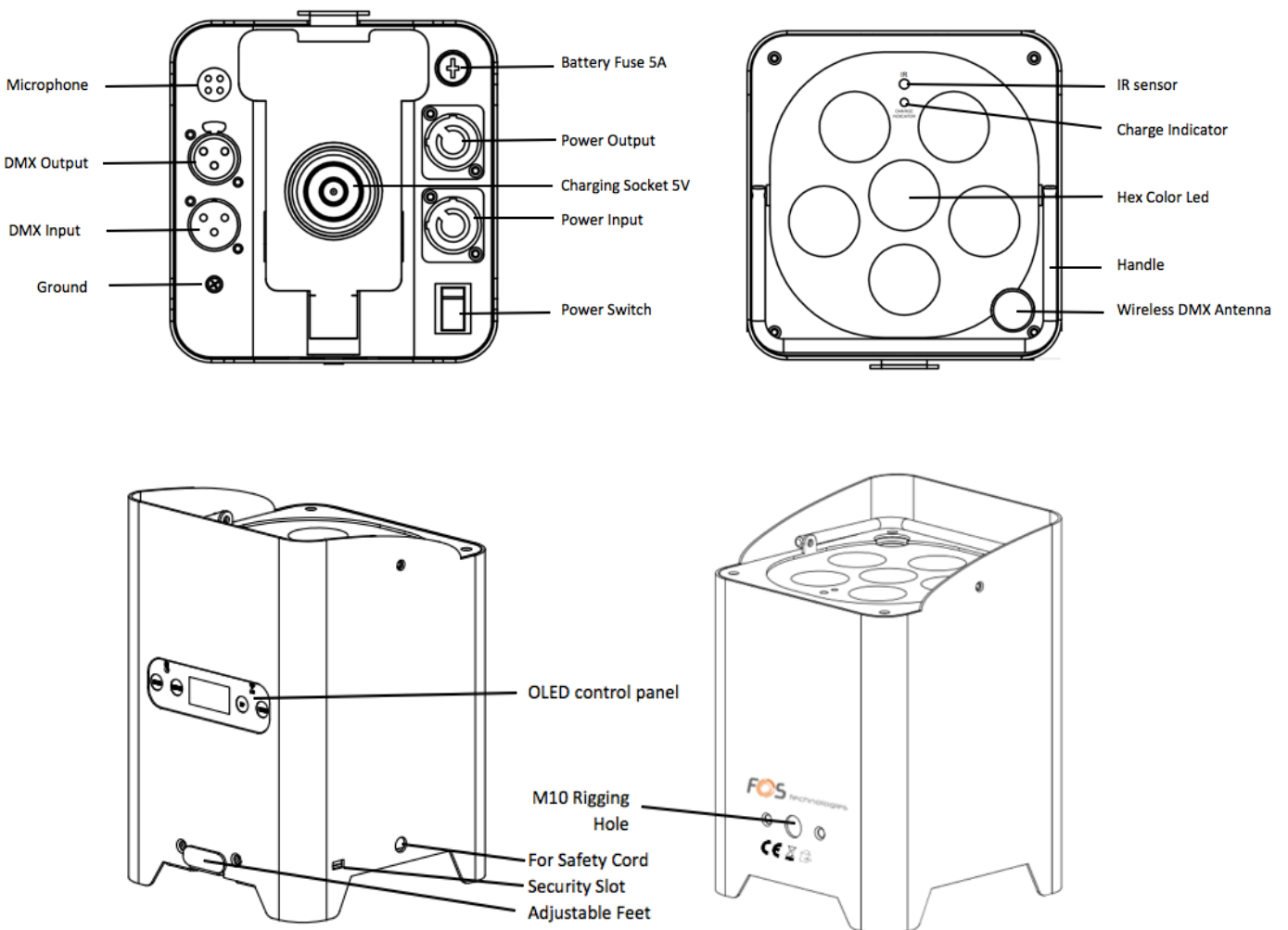

**2.2.2 Fixture Control Panel**

There are 4 touch buttons on the OLED control panel: <MENU>, <ENTER>, <UP> and <DOWN>.

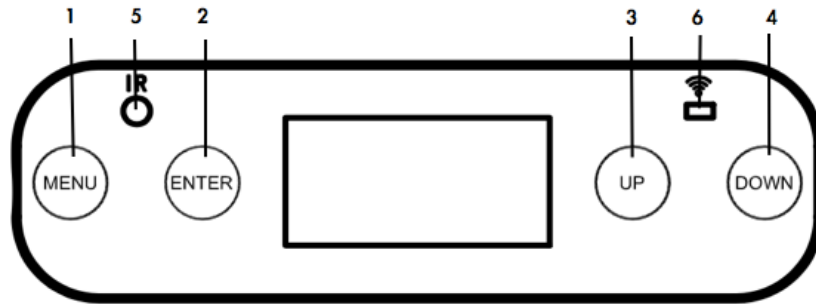

- 1. Menu Select the programming functions or exit from current setup
- 2. Enter Enter the current menu or confirm the current function value
- 3. Up Scroll "UP" through menu list to increase value of current function
- 4. Down Scroll "DOWN" through menu list to decrease value of current function
- 5. IR Infrared control sensor
- 6.  Wireless DMX indicator

### 2.2.3 Fixture Dimensions

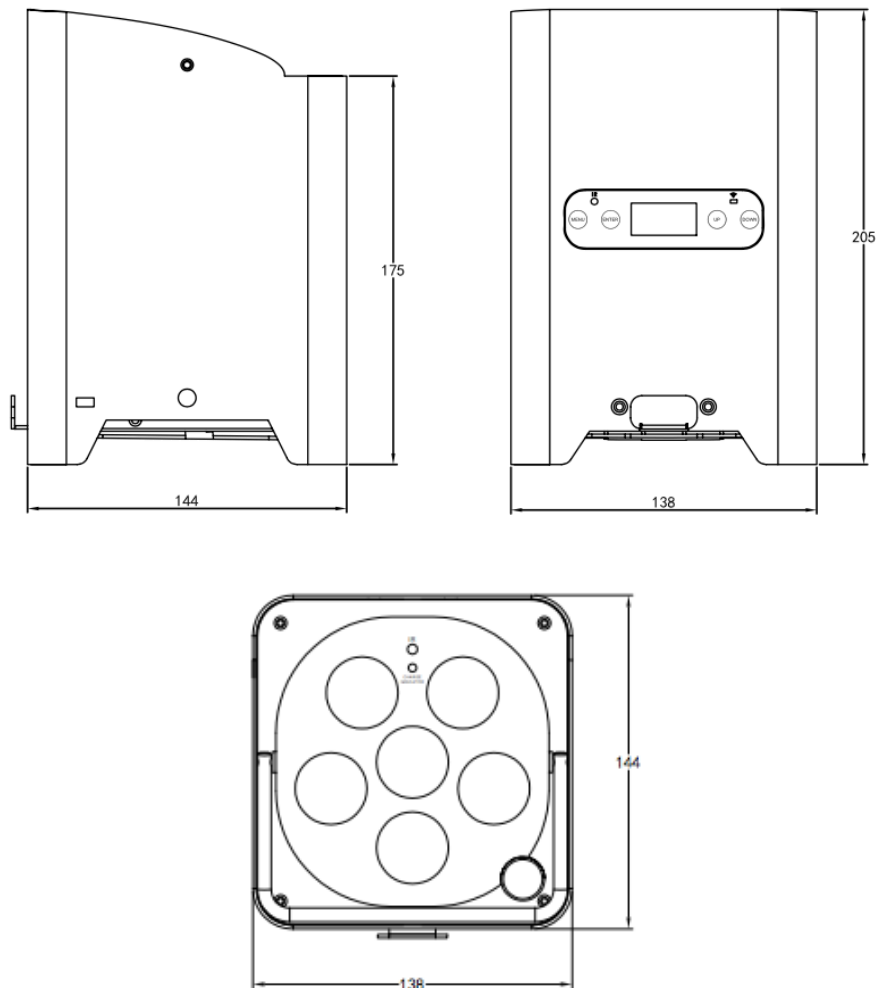

## 2.3 Fixture Temperature

The fixture has temperature protection function. You can easily check fixture temperature via the OLED display information menu.

When fixture temperature is higher than 65 degrees, light output will decrease to 80%. When fixture temperature is higher than 65 degrees, light output will decrease to 60%. When fixture temperature is higher than 75 degrees, leds will go off automatically until temperature comes down to 55 degrees.

## 2.4 Storing the Fixture

Make sure to fully charge all fixtures before storing. Partially charged batteries will lose capacity. Fully recharge every 6 months if not used.

Always remove battery fuse if fixture will be stored for long time (more than 1 month).

## 2.5 Mounting

The fixture can be mounted in several orientations.

2.5.1 The fixture can sit on even and solid floor and work as an upright. It also has a built-in adjustable tilt support. By pushing the tile support, the fixture tile can move up to 25 degrees to wash walls or facades.

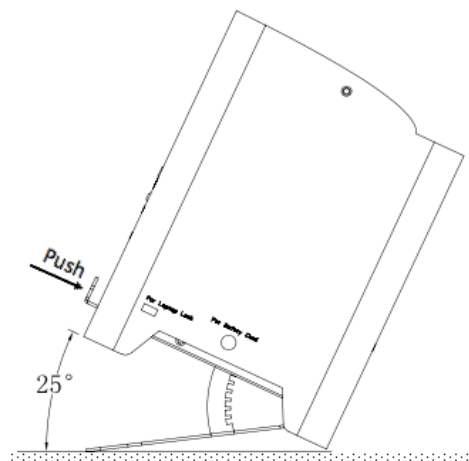

Make sure that the fixture is always placed on even and strong enough surface, and keep it 0.5m away from projection objects.

2.5.2 The fixture has a M10 threaded hold for rigging, and can be mounted on truss as truss warmer.

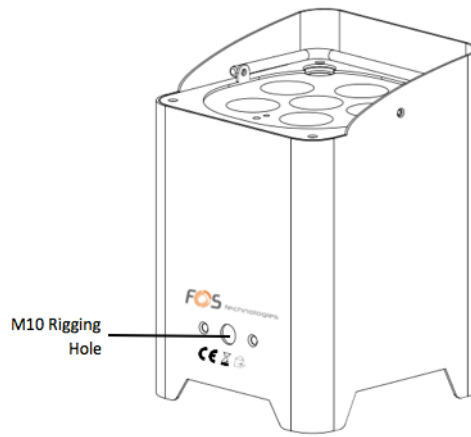

When install the fixture to crossbar or truss, always use an extra safety cord (not supplied with the fixture). Users also need to make sure the crossbar is stable or not moving, and can support a weight of 37 kg (fixture net weight 3.7kg).

For the rest of safety installation, please always respect your local regulations.

## 2.6 Specifications

Electrical	
Power input	100-240VAC 50/60Hz
Power consumption	75W
Power input/output	Powercon input/output
Battery	
Battery type	Rechargeable lithium-ion battery
Charge time	About 5.0 hours
Battery life	5 hours at full color from one full charge Around 5.0 hours full color Around 8 hours at running preset programs Around 12 hours at running single color
Light sources	
Led	6x12W, RGBWA+UV 6-in-1
Beam angle	25°
Field angle	39°
Led average life span	50,000 hours
Control	
Control mode	DMX512, Master/Slave, Stand Alone; Sound control, Wireless DMX, IR Remote Control
DMX channel	6/8/12 channel selectable
Control panel	OLED display with touch buttons



## Physical & Construction

Housing	Rigid metal housing
Housing color	Black
Fixture dimensions	138 x 144 x 205mm
Net weight	3.7 kg
Working temperature	-10°C - 45°C
Charging temperature	0°C - 45°C
IP rating	IP20
Cooling	Natural cooling, silent operation

## 3. BATTERY CHARGE

The fixture has a rechargeable lithium battery and auto-ranging charger built in. Always store the fixtures with full battery. Depleted batteries must be recharged immediately; otherwise fixture performance will suffer.

Battery runtime will decreased time by time. Battery runtime may be slightly shorter than predicted due to different working enviroments.

### 3.1 Battery Charge

There are two ways to charge the fixture.

1. The fixture has a charge connector in the base. The charge case has built-in auto-ranging charger. To charge the fixture, just drop it onto the charging connector in the charging case, and plug the case to the mains. The fixture will start to charge automatically. A normal charging time is about 4-5 hours.
2. Users can also charge the fixture with AC power 100-240V. Connect the fixture power input to the mains with the enclosed power cable, it will start charging automatically.

Battery capacity can be easily seen on the OLED display.

### 3.2 Battery Life Indicator

There is a charge indicator on the top of the fixture. When battery capacity is less than 30%, yellow light will start flashing. When this happens, charge the battery immediately till it is 100% fully charged. Red light will turn on during the whole charging time. Once the battery is fully chaged, the indicator will turn on green.

- Yellow flashing – power less than 30%, need to charge battery
- Red – charging battery
- Green – battery fully charged

It is recommended to charge the fixture at an ambient temperature between 0°C and 35°C.

When charging fixtures in flight case, make sure to keep the case open. Battery always charges whenever fixture is seated on charging connector. If fixture is charged but not in operation, please always keep the power switch “Off”.

**Note: The battery must be replaced with an original one from the manufacturer only.**

## 4. PRODUCT SETUP

This fixture has a built-in rechargeable lithium battery. After it is fully charged, switch on the fixture with the power switch at the bottom of the unit, it will start to run and can be controlled with wireless DMX desk or IR controller.

After operation, please switch off the fixture with its power switch.

### 4.1 OLED Display Back Light

OLED display can be set to turn off in 10-60 second or always “On”.

Follow below steps:

- Continue pressing “Menu” till “Screen save” appears.
- Press “Enter” you will see 10S, you can scroll up/down to set up how many seconds the OLED display turns off, or always “On”
- Press “Enter” to save your setting.

### 4.2 ECO Mode

ECO mode allows the fixture to run longer from a single charge when used in a 3 or more colour program with a slight reduction in intensity.

To set the fixture into eco mode, press the “MENU” button and use the “UP” and “DOWN” buttons to show ECO on the OLED display. Now press the “ENTER” button and use the “UP” and “DOWN” buttons to choose between on or off. Press the “ENTER” button to save the setting.

### 4.3 Menu Map

Menu	Enter	Enter	Enter	Up/Down	Remarks
001 Address	1			001-512	DMX address 001-512
Channel	6CH			6CH 8CH 12CH	Channel mode
DMX Fail	Hold			Hold/Blackout/Auto	DMX Fail Mode
Frequency	600Hz			600Hz 1200Hz 2000Hz 4000Hz 25KHz	Led strobe frequency per second. The higher the frequency is, the worse dimming is, and vice verse.
Manual Color	Red: 255			Red: 0-255 Green: 0-255 Blue: 0-255 White: 0-255 Amber: 0-255 Uv: 0-255	Custom colors (0-100%)
Program	Static Color	Color 1	Strobe 0	Color 01 - Color 30 Strobe 00 - Strobe 10	Static colors + strobe
	Fade	Fade 1	Speed 1	Fade 01 - Fade 05 Speed 01 - Speed 09	Fade mode
	Auto	Speed 1		Speed 01- Speed 09	Auto run + speed
	Sound	Sensitivity		Sensitivity 01 - 09	Sound sensitivity from low to high
Mast/Slave	Master			Mast/Slave	Master/Slave Mode
Wireless DMX	Pair				Wireless DMX Signal Setting
	Clear				
Back Light	10S			10S	Turns off display backlight after XX sec of inactivity
				20S	
				30S	
				Always On	
Information	Version	xx.xx			Version
	Current Time	00H00M00S			Current Run Time
	Total Time	0000H			Total Run Time
	Temperature	xxC			Temperature
Eco Mode	On			On	ECO Setting
				Off	
IR	On			On	IR Setting
				Off	
Menu Lock	On			On	Menu Lock
				Off	
Factory Reset	On			On	To reload to factory default
				Off	

#### 4.4 DMX Addressing

Each fixture must be given a DMX address so that the correct fixture responds to the correct control signals. This DMX address is the channel number from which the fixture starts to “listen” to the digital control information being sent out from the controller.

This fixture has 3 DMX channel modes, 6, 8 and 12 DMX channels. To set up fixture DMX address, first select DMX channel mode. The highest DMX address for this fixture is 512. To set up fixture DMX starting address, follow the steps below:

- Switch on the fixture, press Menu till "Channel" appears;
- Press "Up" or "Down" button to select 6CH or 8CH or 12CH;
- Press "Enter" to confirm your select.
- Press "Menu" repeatedly to come back to "Address 001";
- Set up DMX address by scrolling "Up"/" Down" button.
- Press "Enter" to save your setting.

### 4.5 Wireless DMX Setup

This fixture can be controlled via wireless DMX system. Users need to pair the fixture to wireless DMX transmitter first.

There is one wireless DMX indicator near the OLED display. This indicator shows status of wireless DMX connection.

Indicator Status	Description
Blue light on	Fixture receiving wireless DMX signal from transmitter.
Blue light slow flashing	Fixture already connected to transmitter, but no signal coming from transmitter.
Blue light fast flashing	Fixture no connection to transmitter; fixture keeps. Wireless DMX memory from last pair.
Blue light off	Fixture no connection to transmitter, and no any wireless DMX memory.

#### 4.5.1 Pairing to a New Transmitter

To operate the fixture with wireless DMX, you need to connect your fixtures to a wireless DMX transmitter first.

After fixture is switched on, and if there is no new transmitter, fixture will connect to the old transmitter automatically, no need to re-pair it.

If your fixture has already worked with other wireless DMX transmitter, and now need to work with a new wireless DMX transmitter, you need to erase that wireless DMX memory first before pairing. To clear wireless DMX memory, continue pressing "Menu" till you see "Wireless DMX", press Up/Down to select "Clear" and press "Enter" to clear wireless DMX memory. Then the blue light will turn off in about 5 seconds.

To pair fixture and a new transmitter, after clearing the fixture wireless DMX memory

(make sure wireless DMX indicator is Off), press the pairing button on the transmitter, fixture indicator will start to fast flashing and then stay on, this means pairing succeeds.

In optimal conditions, the master unit can operate up to 200m (visible distance) away from the slave units. Please keep obstacles free between fixtures.

Once the fixture has been linked to a specific transmitter, it will remain linked to that unit until it is linked to another one by clearing the initial wireless DMX signal.

#### **4.5.2 Pairing Between Master/Slave Fixtures**

Before pairing between master and slave fixtures, make sure you have already cleared wireless DMX memory of the slave fixtures, this means all slave wireless DMX indicator should be off.

Now continue pressing "Menu" till you see "Wireless DMX", press Up/Down to select "Pairing" and press "Enter". Then the wireless DMX indicator on the master fixture and all slave fixtures will start fast flashing, and then stay on. Now pairing succeeds.

Now you can operate your fixtures wirelessly in Master/Slave mode.

#### **4.5.3 Clear Wireless DMX Memory**

To clear wireless DMX signal, continue pressing "Menu" till you see "Wireless DMX", press Up/Down to select "Clear" and press "Enter" to erase old wireless DMX signal. Wireless DMX indicator will turn off in 5 seconds.

If your fixture is a master unit (i.e. it is in wireless DMX transmit mode), the wireless DMX memory of both Master unit and Slave units will be erased at the same time.

If your fixture is a slave unit, you cleared wireless DMX memory of that fixture only.

#### **4.6 DMX Signal Fail**

To access the DMX signal fail setting, press the "MENU" button and use the "UP" and "DOWN" buttons to show FAIL on the OLED display. Now press the "ENTER" button and use the "UP" and "DOWN" buttons to choose between Hold, Blackout or Auto mode. Press the "ENTER" button to save your setting.

Press the "MENU" button to exit out of the above options.

## 5. OPERATION

### 5.1 DMX Control Mode

This function will allow users to control individual fixture with a standard DMX 512 console. Below is fixture DMX Channel Chart.

Channel Mode	Channel	Function	DMX Value	Description
6 CH	1	Red	0-255	0-100%
	2	Green	0-255	0-100%
	3	Blue	0-255	0-100
	4	White	0-255	0-100
	5	Amber	0-255	0-100%
	6	UV	0-255	0-100
8 CH	1	Dimming	0-255	0-100%
	2	Strobe	0-10	No function
			11-255	Strobe from slow to fast
	3	Red	0-255	0-100%
	4	Green	0-255	0-100%
	5	Blue	0-255	0-100%
	6	White	0-255	0-100%
	7	Amber	0-255	0-100%
8	UV	0-255	0-100%	
12 CH	1	Dimming	0-255	0-100%
	2	Strobe	0-10	No function
			11-255	Strobe from slow to fast
	3	Red	0-255	0-100%
	4	Green	0-255	0-100%
	5	Blue	0-255	0-100%
	6	White	0-255	0-100%
	7	Amber	0-255	0-100%
	8	UV	0-255	0-100%
	9	Colors macro & white balance	0-10	No function
			11-30	R:100% G:0-100% B: 0
			31-50	R: 100%-0 G100% B: 0
			51-70	R:0 G:100% B: 0-100%
			71-90	R: 0 G: 100%-0 B: 100%
			91-110	R: 0-100% G:0 B: 100%
111-130			R: 100% G: 0 B: 100%-0	
131-150			R: 100% G: 0-100% B: 0-100%	
151-170	R: 100%-0 G:100%-0 B: 100%			

12 CH	9	Colors macro & white balance	171-200	R: 100% G: 100% B:100%
			201-205	White 1
			206-210	White 2
			211-215	White 3
			216-220	White 4
			221-225	White 5
			226-230	White 6
			231-235	White 7
			236-240	White 8
			241-245	White 9
			246-250	White 10
	251-255	White 11		
	10	Auto run	0-10	No function
			11-40	RGB color mixing
			41-70	Cyan, orange, purple, candlelight, hot pink color mixing
			71-100	RGBWA color mixing
			101-130	10-color color mixing
			131-160	RGB color changing
			161-190	Cyan, orange, purple, candlelight, hot pink color changing
			191-220	RGBWA color changing
	11	Auto speed	0-255	From slow to fast
	12	Sound	0-10	No function
11-255			Sound mode	

## 5.2 Master/Slave Mode

The fixture has a built-in wireless DMX transceiver inside. Fixtures can operate Master/Slave mode wirelessly or with physical XLR cable linking. In Master/Slave mode, one fixture will work as Master fixture, other fixtures in the daisy chain will work in synchronization with the Master fixture.

Continue pressing “Menu” till “Mast/Slave” appears, scroll “Up” or “Down” to set up one fixture as Master unit. Then press “Enter”, the master unit will start to pair all slave units automatically. Wireless DMX indicator keeps flashing during paring time. Wireless DMX indicator keeps On if pairing succeeds.

## 5.3 Auto Run Mode

The fixture has preset color mixing and fading programs that can be activated from the OLED control panel for auto running. To access this, follow below steps:

- Press button "Menu" until "Program" appears.
- Press "Up" or "Down" to scroll up/down to select "Auto" and "Color";
- - Press "Enter" to confirm your run mode;
- - Scroll "Up" or "Down" to select Auto programs.

#### 5.4 Sound Mode

The fixture can operate at sound mode to activate built-in programs with music.

Continue pressing "Menu" till "Program" appears. Press "Up" or "Down" to scroll up/down to select "Sound". Press "Enter" to save the setting.

Press "Up" or "Down" to adjust sound sensitivity from high to low (from 1 to 9).

#### 5.5 Manual Colors

Users are allowed to program their own color effects and save to your fixture in "Manual Color".

Press "Menu" button until you see "Manual Color". Scroll "UP" or "DOWN" to select the color, then press "Enter" to confirm the color selection. Now press "UP" or "DOWN" to set color intensity. Press "ENTER" to save your setting. Press "MENU" to exit from current setup.

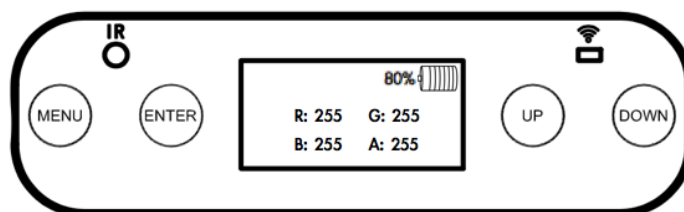

When the fixture is switched off and then on again, the fixture will go back to what it was set at.

#### 5.6 IR Remote Control

This operation mode allows users to control the fixture with an infrared remote controller. The remote controller can help you to achieve almost all functions.



**To control your fixture with IR controller, please set up Wireless DMX to "Off".**



To activate IR remote control, press "Menu" until "IR" appears, press "Up" or "Down" button and select "On". Press "Enter" to save the setting.



To control the fixture with this IR remote controller, make sure to point the controller directly to the IR receiving sensors on the product. Make sure there are no objects between the controller





and the fixture.

- 1 - Set the fixture into blackout (LED on/off).
- 2 - Adjust auto, strobe & fade speed, sound sensitivity, DMX address, DMX channel, brightness etc.
- 3 - Run auto mode, use "Speed" button followed by the   buttons to adjust auto speeds.





4 – Run sound program, use   buttons to adjust sound sensitivity.



5 – Run strobe program, use   buttons to adjust strobe speed.



6 – Set auto/fade speed, Press this button followed by   buttons to adjust program speed.

7 – Set the fixture into master or slave mode.

8 – Run fade mode. Use "Speed" button followed by   buttons to adjust fade speed.

9 - Set DMX address. Press this button followed by   to set up DMX address. Press this button again followed by   to select DMX channel.

10 – Set the fixture in full brightness. Press this button followed by   buttons to adjust brightness.

11 – Set the fixture in ECO mode. Press this button followed by   buttons to turn ECO mode on/off.

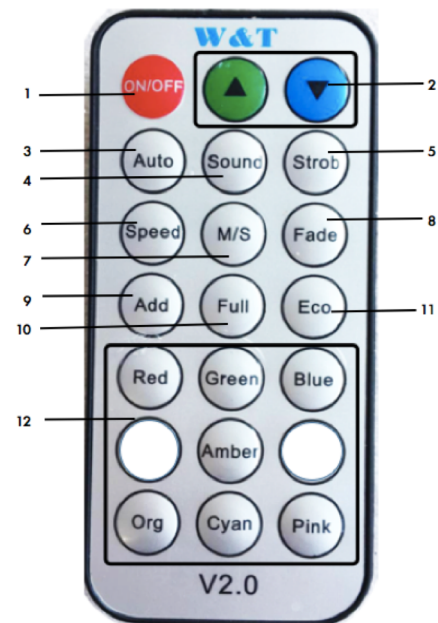

## 6. MAINTENANCE

### 6.1 General Maintenance

The operator has to make sure that the safety-related and machine-technical installations are to be inspected by an expert once a year in the course of an acceptance test.

The operator has to make sure that safety-related and machine-technical installations are to be inspected by a skilled person once a year.

The following points have to be considered during the inspection:

- Make sure connections are clean and totally dry before linking equipments or supplying electric power.
- All screws used for installing the fixture or parts of the fixture have to be tightly connected and must not be corroded.

The fixture has optical lenses; users should clean the lenses periodically to optimize light output. The cleaning frequency depends on the environment in which the curtain system is installed. Damp, smoky or particularly dirty surrounding can cause greater accumulation of dirt on the lenses. Even in a clean type of surroundings, it is suggested to clean the lens and housing at least once a month. It is suggested to use a soft cloth using normal glass cleaning fluid.

The following points have to be considered during the maintenance:

- Switch off the fixture before cleaning.
- Clean the lens with a mild solution of glass cleaner or isopropyl alcohol, and a soft, lint free cotton cloth or a lens cleaning tissue.
- Gently polish the external glass surfaces until they are free of haze and lint.

## 6.2 Fuse Replacement

In case fuse is blown, you need to replace it. Unplug the fixture from power, remove the 4 screw from the housing to find the fuse holder. Open the fuse holder by turning it anticlockwise; remove the blown fuse from the holder and replace it with the exact same type and rating one. Close the fuse holder by turning it clockwise to tighten it. Screw back the base to the housing.

**Always replace a blown fuse with another of the same type and rating.**



# **Wireless Battery Uplighter FOS Luminus PRO RGBWA+UV**

## **USER'S MANUAL**



Dealer info:

Copyright reserved

Manual version: Ver. 1.0

Date: 20181006